

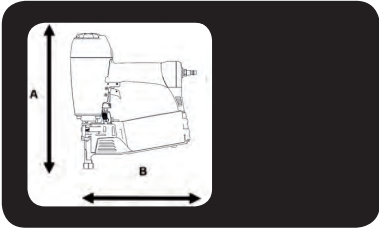

Paslode[®]

CNP75.1





CNP75.1

		A = 358 mm B = 296 mm C = 154 mm
		= 2,8 kg



2,5 l (6 bar) /
Ps max. = 8,3 bar

	L = 101 dBA
	L pA.1s = 93 dBA L pA.1s1m = 88 dBA
EN 12549+EN ISO 4871 EN12096 : 1997 ISO 8662-11	Vibration = 2,9 m/s²

325 x =
Paslode 0° Coil Nails

Paslode IN-tape	D max. = 5,8 mm L = 50-75 mm d = 2,1-3,0 mm Ballistic nails : 30-40 mm



	<p>Sequential trigger actuation/ Einzelauslösung/ enkelschots/ Déclenchement du tir - mode séquentiel/ Funcionamiento secuencial "en continuo"/ Gatilho de actuação sequencial/ Funcionamento sequenziale (colpo a colpo)/ Enkeltskudds aftrækker/ Enkelskott/ Enkeltskudds avtrekker/ Kertalaukaisu/ Úksiklasu meetodil töötamine/ Uruchromienie spustu sekwencyjne/ Sekvenční spoušť/ Egyes lövés (szakaszosan működtetett elsütő billentyűvel)/ Posamezno proženje/ Kontaktirajte singli / Последовательная активация при нажатии на курок/ Секвенčná aktivácia spúšte/ التشغيل بالزر (التسلسلي) المقيد / Kontaktní spoušť/ Sorozatlövés (folyamatosan behúzott elsütő billentyűvel)/ Kontaktno proženje/ Kontaktirajte pokretanje/ Контактная активация при нажатии на курок/ Kontaktná aktivácia spúšte/ التشغيل بتلامس الزر / Kontaktinis paleidimo mechanizmas/ Kontakta palaiades iedarbināšana Raðkveikjvirkjun</p>
	<p>Contact trigger actuation/ Kontaktauslösung/ repeterend schieten/ Déclenchement du tir - mode rafale/ Funcionamiento por contacto "clavo a clavo"/ Gatilho de actuação por contacto/ funcionamiento a contatto/ Stødskydning's aftrækker/ Støtskjutning/ Støtspikrings avtrekker/ Kosketuslaukaisu/ Automaatmeetodil töötamine/ Uruchromienie spustu przez kontakt/ Kontaktní spoušť/ Sorozatlövés (folyamatosan behúzott elsütő billentyűvel)/ Kontaktno proženje/ Kontaktirajte pokretanje/ Контактная активация при нажатии на курок/ Kontaktná aktivácia spúšte/ التشغيل بتلامس الزر / Kontaktinis paleidimo mechanizmas/ Kontakta palaiades iedarbināšana/ Snertikveikjvirkjun</p>







<p>CNP75.1 PNEUMATIC COIL NAILER Code: 505353 Trigger actuation: Sequential</p>  <p>0° coil nails IV - tape D= 5,8 mm (max) L= 56-75 mm Ø = 2.1-3.0 mm Ballistic nails: 30-40 mm</p>	 <p>Model : CNP75.1 No. 505353</p>	<p>CNP75.1 PNEUMATIC COIL NAILER Code: 505354 Trigger actuation: Contact</p>  <p>0° coil nails IV - tape D= 5,8 mm (max) L= 56-75 mm Ø = 2.1-3.0 mm Ballistic nails: 30-40 mm</p>	 <p>Model : CNP75.1 No. 505354</p>
--	---	---	---



No. 575641



ITW Befestigungssysteme GmbH
30966 Hemmingen, Germany.

					
No. 014748 + No. 576671		No. 574425	No. 014121		

Accessories

 <p>No. 574494 Hanger</p>	 <p>No. 505203 Magazine insert</p>	 <p>No. 151299 / No. 576216 0,5 l oil / 1 l oil</p>
--	---	---

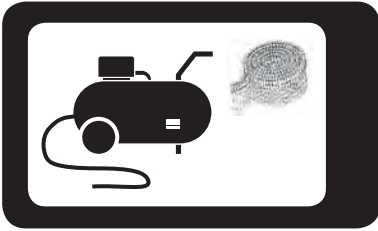

014 748

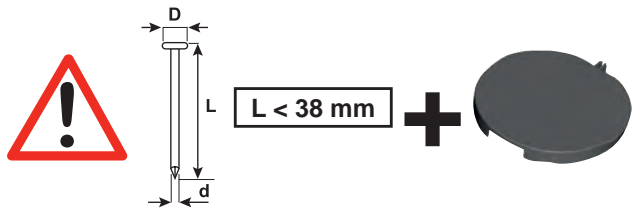
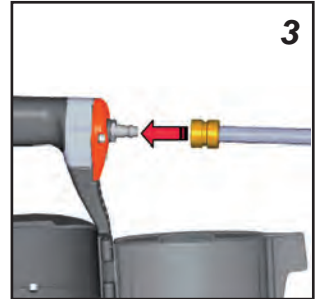
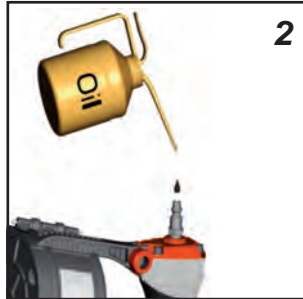
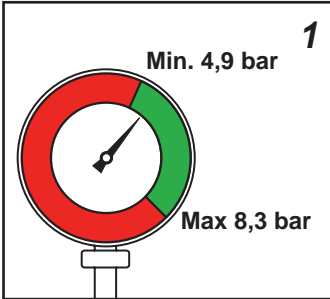

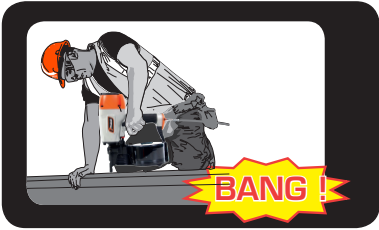

014 748

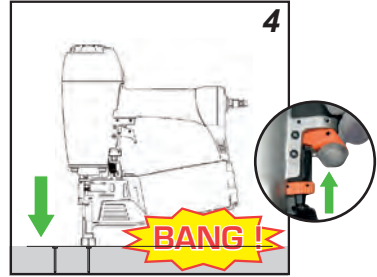
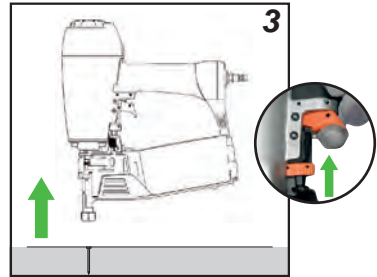
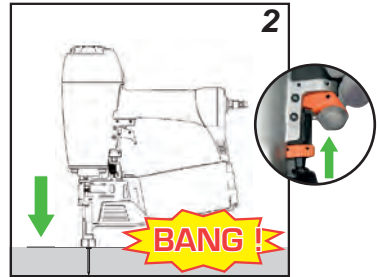
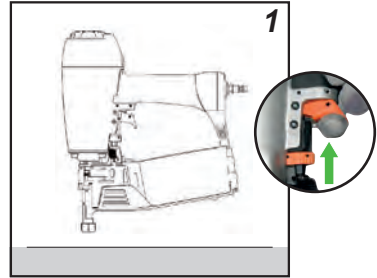
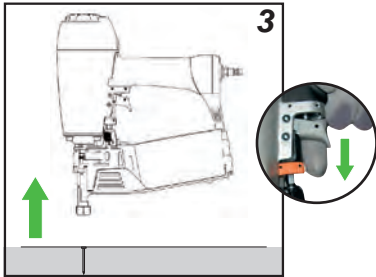
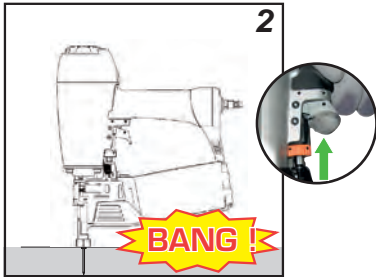
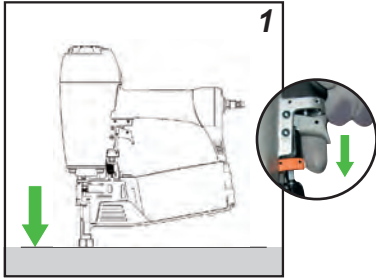

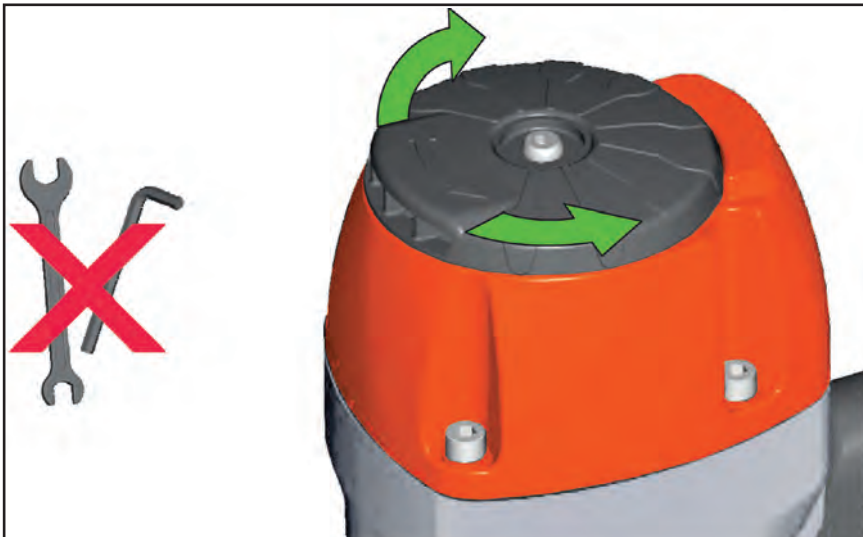
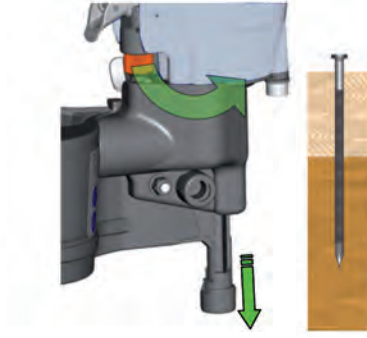
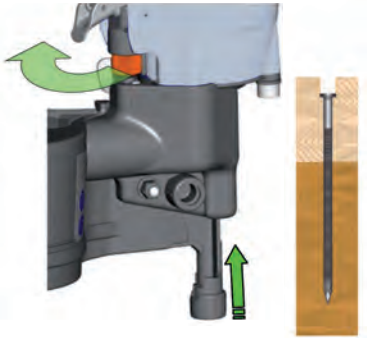
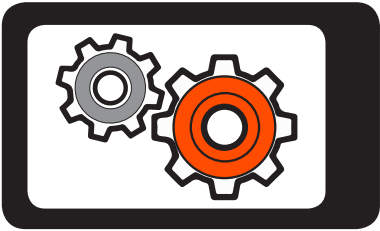

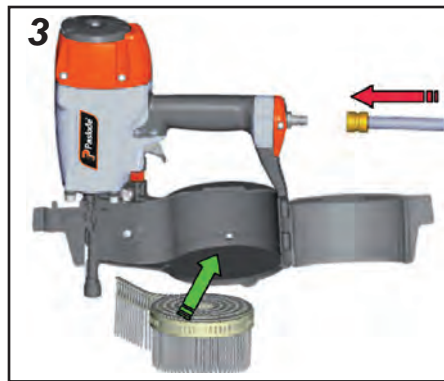
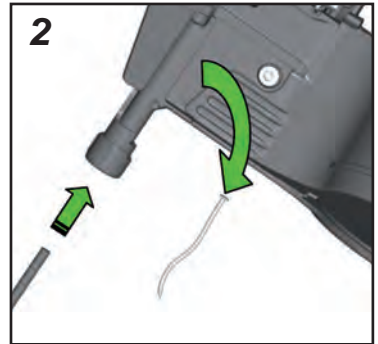
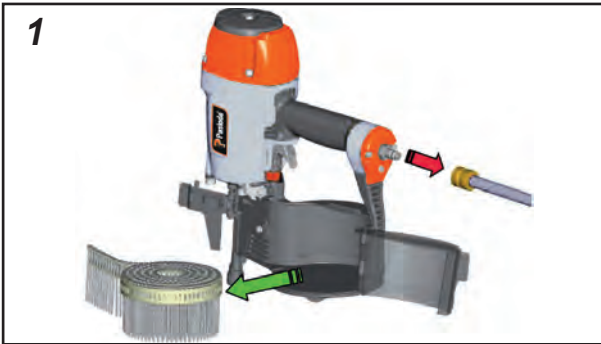
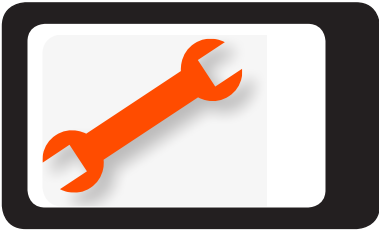

YY/WW....



YY= Year of manufacture
WW = Week of manufacture

**Resting position/ Ruheposition/ Position de repos/ Ruststand/
Posición de descanso/ Posizione di riposo/ Posição de des-
canso/ Pozycja spoczynku/ Klidová poloha/ Nyugalmi állapot/
Положение в нерабочем состоянии/ Θέση αδράνειας/ Hviles-
tilling/ Viloläge/ Hvileposisjon/ Leroasento/ Položaj mirovanja/
Pokoiová poloha/ Položaj mirovanja/ وضع السكون / Ramybės
padėtis/ Ooteasend/ Miera stāvoklis/ Hvíldarstaða**





ITW CONSTRUCTION PRODUCTS EUROPE
Code 576671(04/2019)
www.spitpaslode.com